

DP-15



DP-15

▶		
▶	8mm,	304
▶		
▶	15mm	
▶	IP64	
▶	0.5	

▶	
▶	
▶	
▶	
▶	

	DP-15
	±5mm
	0.5
	30-80g
	IP64
	Ø8
	steel
	0 to 40
	3m
	35g

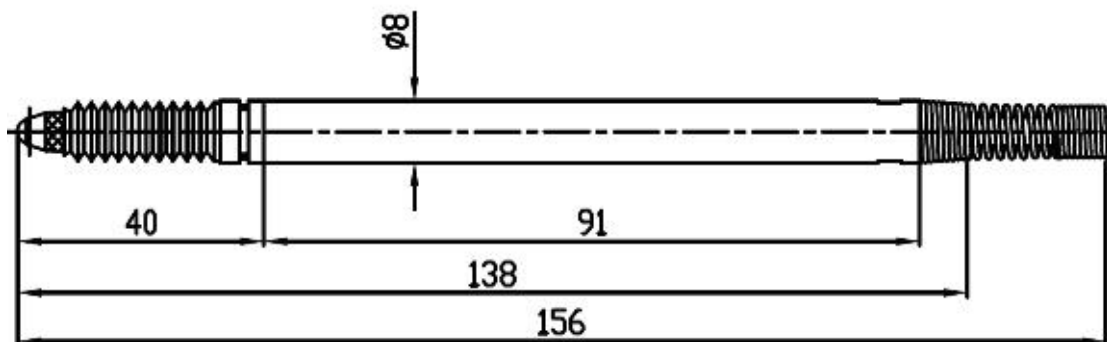

触头

标配 OP-291
材质：不锈钢
触点：球面

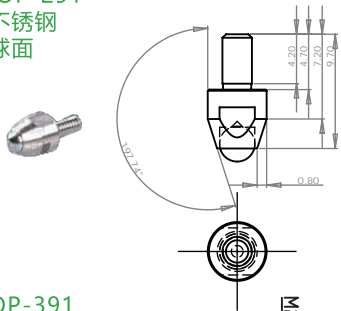

选配①OP-492
材质：钨钢
触点：球面

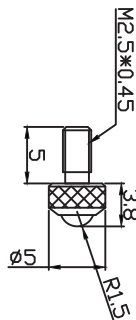

选配②OP-432
材质：钨钢
触点：平面

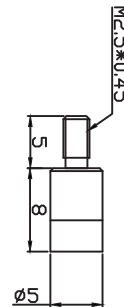

选配③OP-391
材质：PEK
触点：球面

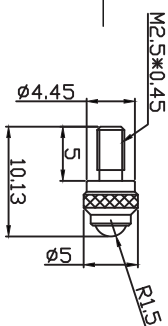

选配④OP-211
材质：不锈钢
触点：一字面

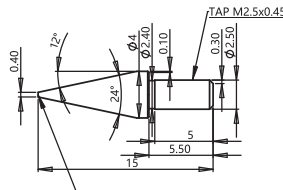

选配⑤OP-441
材质：钨钢
触点：针型平面

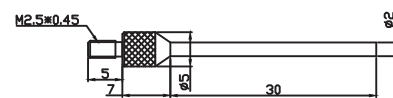

安装支架

本公司有标准的夹具配件供用户选择使用，用户也可以自行定制安装夹具，选配件需额外购买。夹具材质要求为非导磁材料，忌讳磁铁或铁等带磁或者导磁性材质。

标配C型套

型号：OP-610

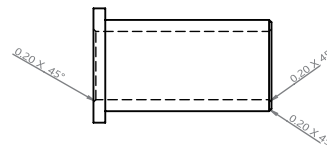
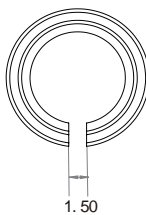
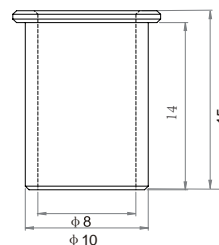
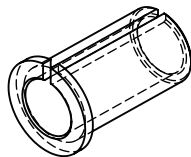

选配螺纹套

型号：OP-080

